

REV	DESCRIPTION	DATE	APPROVED
00	INITIAL COMPOSITE DRAWING	8/7/07	MD

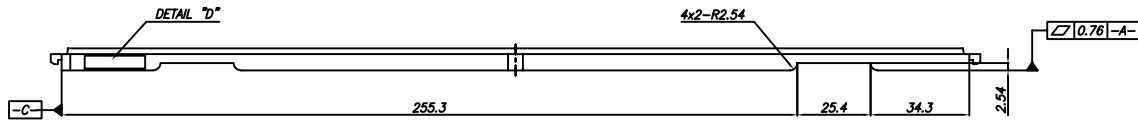

LGA 8.95mm x 11.25mm
KS - 87376 REV.00

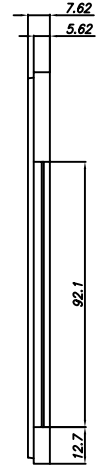
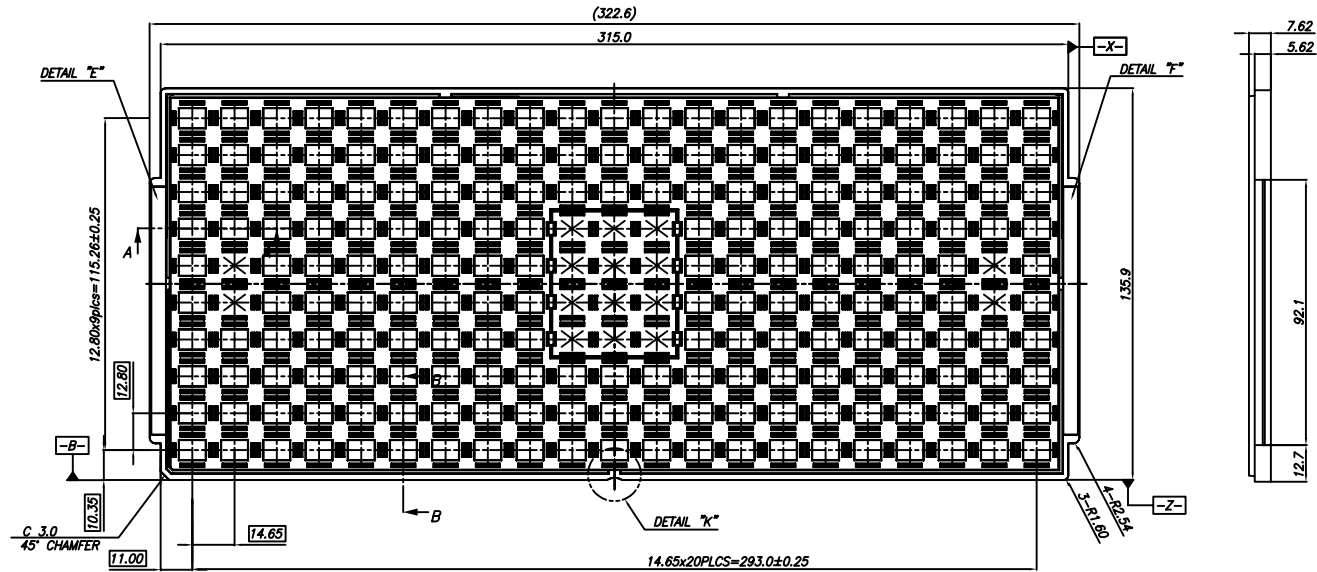
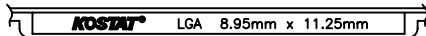

DETAIL "D"
(SCALE:2/1)

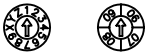

DATE DETAIL
(SCALE:2/1)

DETAIL "E"
(SCALE:2/1)



DETAIL "F"



1630 McCarthy Blvd.
Milpitas, CA. 95035
Phone: 408-432-1900
LTC Confidential

PIECE PART DRAWING
SIP 11.25MMX9MM
BLACK TRAY

DRAWING NO.

50-8042 REV0

APPROVALS
DRAWN: MUTHIEND / D.PRUITT
CHECKED: R.RANGANATHAN

DATE:

TOLERANCES UNLESS OTHERWISE SPECIFIED:

FRACTIONS
N/A

SCALE
N/A

DECIMALS
XXX ± 0.025
XXXX ± 0.013

ANGLES
± 1

SIZE
N/A

SHEET
1 OF 4

REV	DESCRIPTION	DATE	APPROVED
00	INITIAL COMPOSITE DRAWING	8/7/07	MD

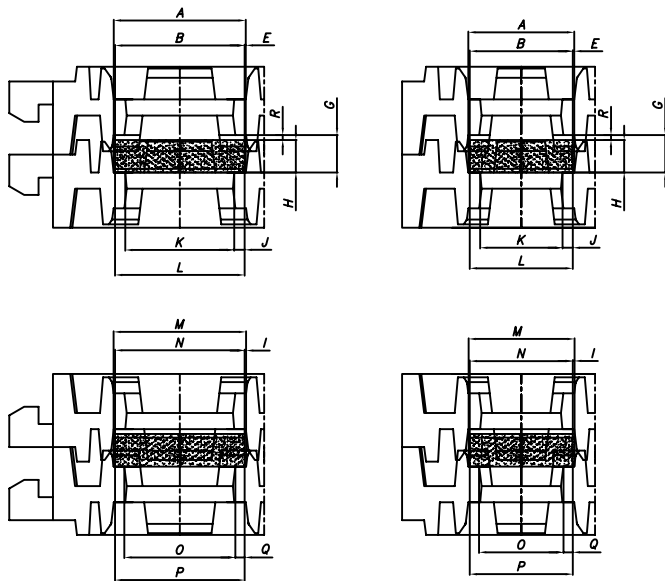

SIMULATION CRITERIA					
1. $A > B$	PACKAGE NESTING				
2. $E > D$	PACKAGE LATERAL PLAY				
3. $G > H$	PACKAGE VERTICAL PLAY				
4. $I > O$	PACKAGE LATERAL PLAY AT FLIPPED				
5. $K < L$	PACKAGE SEATING				
6. $J > O$	PACKAGE SEATING PLAY				
7. $M > N$	PACKAGE NESTING AT FLIPPED				
8. $O < P$	PACKAGE SEATING AT FLIPPED				
9. $Q > O$	PACKAGE SEATING PLAY AT FLIPPED				

No.	Section "A" Condition	Nominal	Max. TRAY Min. PKG		Results
			Wc 1	Wc 2	
1	Tray A	11.450	11.530	11.370	Pass
	Pkg. B	11.250	11.150	11.350	
2	Gap. E(A-B)/2	0.100	0.190	0.010	Pass
3	Tray G	3.250	3.380	3.120	Pass
	Pkg. H	2.820	2.720	2.920	
4	Gap. R(B-H)	0.430	0.680	0.200	Pass
5	Gap. I (M-N)/2	0.125	0.215	0.035	Pass
	Tray K	9.480	9.590	9.330	Pass
	Pkg. L	11.250	11.150	11.350	
6	Gap. J (R-Q)/2	0.695	0.780	1.010	Pass
	Tray M	11.500	11.580	11.420	Pass
	Pkg. N	11.250	11.150	11.350	
9	Tray O	9.380	9.780	9.000	Pass
	Pkg. P	11.250	11.150	11.350	
10	Gap. Q(P-O)/2	0.810	0.695	0.925	Pass

No.	Section "B" Condition	Nominal	Max. TRAY Min. PKG		Results
			Wc 1	Wc 2	
1	Tray A	9.200	9.280	9.120	Pass
	Pkg. B	8.950	8.850	9.050	
2	Gap. E(A-B)/2	0.125	0.215	0.035	Pass
3	Tray G	3.250	3.380	3.120	Pass
	Pkg. H	2.820	2.720	2.920	
4	Gap. R(B-H)	0.430	0.680	0.200	Pass
5	Gap. I (M-N)/2	0.125	0.215	0.035	Pass
	Tray K	7.140	7.270	7.010	Pass
	Pkg. L	8.950	8.850	9.050	
7	Gap. J (R-Q)/2	0.905	0.790	1.020	Pass
	Tray M	9.200	9.280	9.120	Pass
	Pkg. N	8.950	8.850	9.050	
9	Tray O	7.330	7.460	7.200	Pass
	Pkg. P	8.950	8.850	9.050	
10	Gap. Q(P-O)/2	0.810	0.695	0.925	Pass

LINEAR
TECHNOLOGY
1630 McCarthy Blvd.
Milpitas, CA. 95035
Phone: 408-432-1900
LTC Confidential

PIECE PART DRAWING
SIP 11.25MMX9MM
BLACK TRAY

DRAWING NO.
50-8042 REV0

APPROVALS	DATE:	TOLERANCES UNLESS OTHERWISE SPECIFIED:		
DRAWN: M.D. THIENO / D. PRUITT		FRACTIONS N/A	DECIMALS HUNDRETHS = ± 0.02 THOUSANDS = ± 0.015	ANGLES ± 1
CHECKED: R. RANGANATHAN		SCALE N/A	SIZE N/A	SHEET 2 OF 4

REV	DESCRIPTION	DATE	APPROVED
00	INITIAL COMPOSITE DRAWING	8/7/07	MD

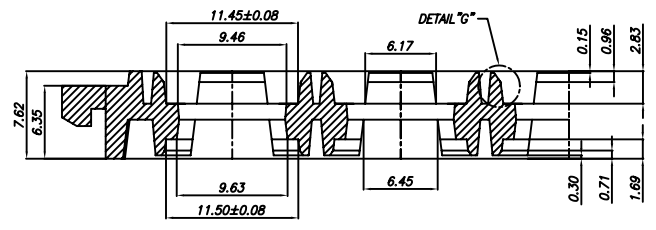

SECTION "A-A"
(SCALE:4/1)

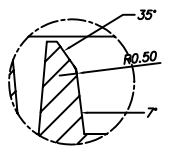

DETAIL "G"
(SCALE:12/1)

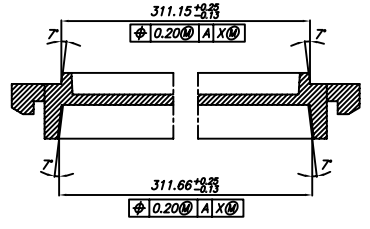

TRAY STACKING DETAIL
(SCALE:4/1)

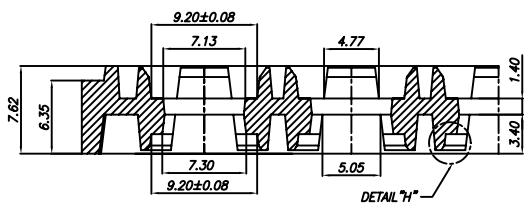

SECTION "B-B"
(SCALE:4/1)

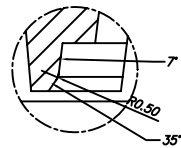

DETAIL "H"
(SCALE:12/1)

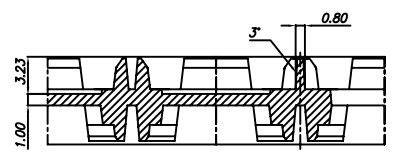
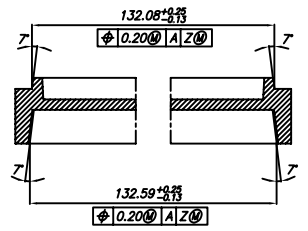

VACUUM CELL
(SCALE:4/1)

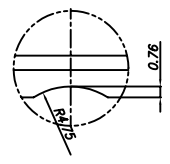

DETAIL "K"
(SCALE:4/1)

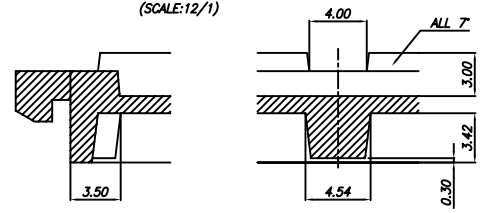

SLIP LOCK DETAIL
(SCALE:5/1)

LINEAR TECHNOLOGY
 1630 McCarthy Blvd.
 Milpitas, CA. 95035
 Phone: 408-432-1900
 LTC Confidential

PIECE PART DRAWING			
SIP 11.25MMX9MM			
BLACK TRAY			
DRAWING NO.			
50-8042 REV0			
TOLERANCES UNLESS OTHERWISE SPECIFIED:			
FRACTIONS	DECIMALS	ANGLES	
N/A	± 0.01	± 1	
CHECKED:	SCALE	SIZE	SHEET
R.RANGANATHAN	N/A	N/A	3 OF 4

REV	DESCRIPTION	DATE	APPROVED
00	INITIAL COMPOSITE DRAWING	8/7/07	MD

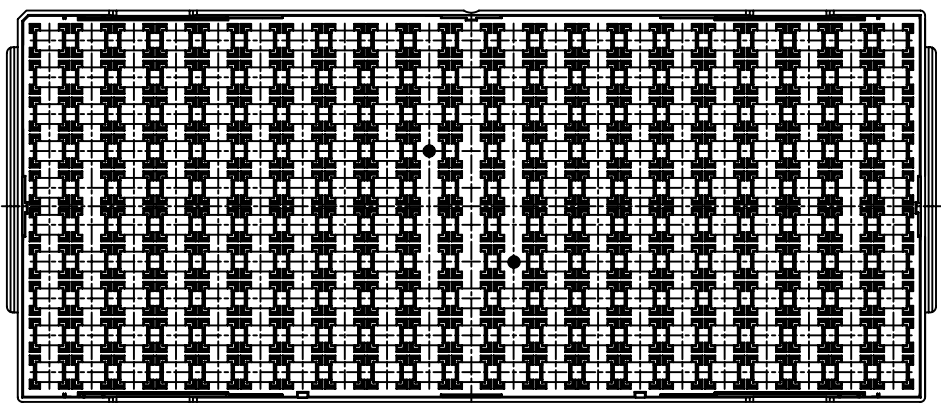

BOTTOM VIEW
(SCALE:1/1)

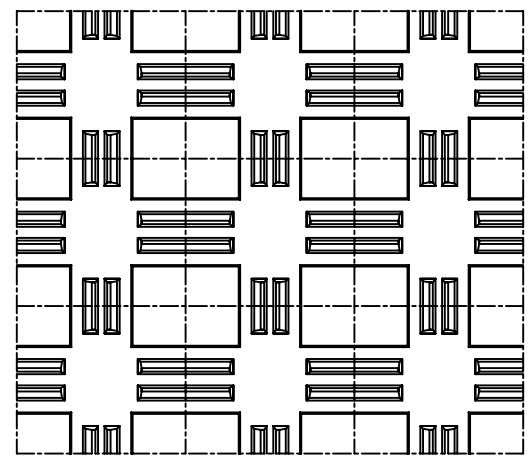

TOP VIEW
(SCALE:4/1)

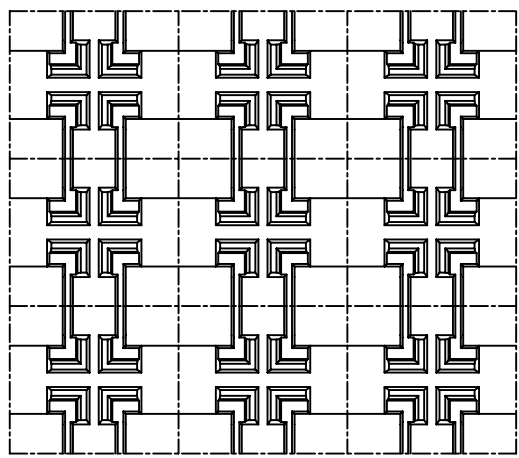

BOTTOM VIEW
(SCALE:4/1)

 1630 McCarthy Blvd. Milpitas, CA. 95035 Phone: 408-432-1900 LTC Confidential		PIECE PART DRAWING	
		SIP 11.25MMX9MM BLACK TRAY	
DRAWING NO.		50-8042 REV0	
APPROVALS	DATE:	TOLERANCES UNLESS OTHERWISE SPECIFIED:	
DRAWN: M.DHIENO / D.PRUITT		FRACTIONS N/A	DECIMALS MILS = ± 0.02 THOUS = ± 0.013
CHECKED: R.RANGANATHAN		SCALE N/A	ANGLES ± 1
		SIZE N/A	SHEET 4 OF 4